

# CATALOGO

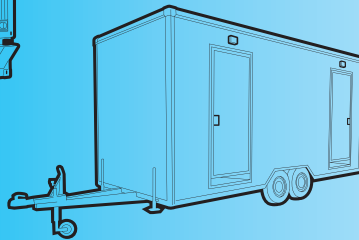
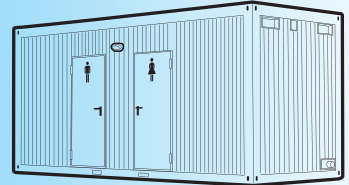
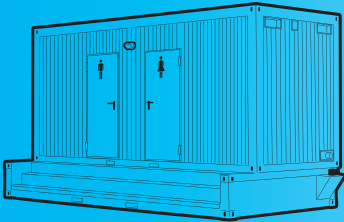
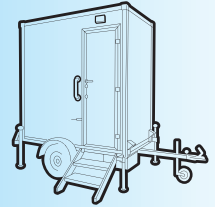
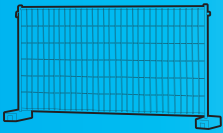
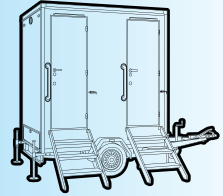
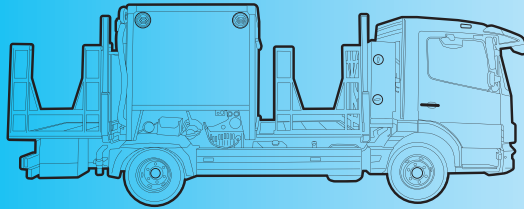

**SOLUZIONI SANITARIE MOBILI**

# COSA FACCIAMO

## Consulenza

Per ogni fase del progetto: progettiamo, pianifichiamo, consigliamo i prodotti, montiamo, smontiamo le strutture, installiamo i bagni, calcoliamo in numero ideale di WC e/o docce, coordiniamo e controlliamo.

## Servizio pulizia

Personale specializzato nelle pulizie di tutti i WC mobili e fissi.

## Servizio stand by

Assistenza e controllo durante gli eventi.

## Soluzioni individuali

Serbatoi di scarico.  
Pompe acque di scarico.  
Recinzioni e transenne.

## Zona dell'evento

Lo smaltimento dei rifiuti avviene in collaborazione con partner professionali.

## Servizio completo

Tutti i lavori di installazione senza problemi: collegamento all'acqua, alla canalizzazione e alla rete elettrica con un unico partner.

## Smaltimento acque reflue

Direttamente nella canalizzazione attraverso le nostre pompe di scarico, oppure raccolte nei nostri serbatoi.

## Gestione acqua fresca

Il nostro personale specializzato si occupa dell'installazione e dei vari collegamenti, così come dell'assistenza. Inclusa la fornitura dei vari raccordi, dei tubi e degli attrezzi necessari.

## Logistica

La consegna, il ritiro e lo smaltimento delle acque reflue, avviene con i nostri mezzi.

## I mezzi di servizio

I nostri mezzi moderni e il personale specializzato garantiscono un servizio affidabile e professionale.

## Consegna e installazione

Il team TOI TOI offre un servizio completo "chiavi in mano": consegna, posa e ritiro. I lavori d'installazione possono variare in base ai vari modelli ordinati. In ogni caso, avvengono sempre a norma di legge.

## Pulizia

La TOI TOI AG, da molta importanza alla qualità del proprio servizio, tutti i collaboratori sono formati e svolgono il proprio lavoro con impegno e passione. Per garantire questo obiettivo. L'azienda esegue regolari controlli di qualità interna.

## Smaltimento

La TOI TOI AG da sempre è rispettosa dell'ambiente. La Direzione si assume in prima persona l'impegno a creare la mentalità dei suoi collaboratori e pone l'attenzione alla innovazione tecnologica che permette di ridurre gli sprechi. Inoltre, l'azienda lavora a stretto contatto con i Laboratori Cantionali e garantisce lo smaltimento degli scarichi in impianti di depurazione. Tutti i suoi prodotti di pulizia sono registrati presso l'Ufficio federale della sanità pubblica (UFSP) – per salvaguardare l'ambiente.

# PAGINA CONTENUTI

Water, Plus Wash, Water UP, Hygiene+, Fresh, Plus, Mini, Cabina multi-orinatoio, Serbatoio da appartamento, Orinatoio, Mini Orinatoio

WC ECO, WC ECO Plus, WC VIP Duo, WC VIP, WC VIP Maxi, WC now, WC VIP Futuro, WC-Doccia VIP

Mini Bagno mobile, Bagno mobile S, Bagno mobile M, Bagno mobile L

WC Cubus D/U, WC Cubus U, WC Cubus Edilizia, WC Doppelstar, WC Basic Line, WC Maxi, Orinatoio Maxi, Doccia Maxi, Doccia Basic Line, WC-Doccia Cubus Combi, WC-Doccia Combi 1.8

WC Premium D/U, WC Premium U, WC Premium D, WC DeLuxe, Orinatoio DeLuxe, Bagno DeLuxe

WC Trailer VIP Cerebral, Doccia Trailer VIP Cerebral, Cabine sanitarie Cap Cerebral, WC Container Cap

Hotmobil, Pompa acque di scarico, Pompa da cucina, Scale speciali

Lavamani Maxi, Care Hand Sanitizer, Lavabo multiplo, Cabine sanitarie speciali, Rimorchi WC Robustar

1'000 litri, 4'000 litri, 10'000 litri

Transenne (modello Polizia), Recinzioni temporanee e mobili

**Cabine sanitarie**

**Rimorchi WC e docce**

**Bagno mobile**

**Container sanitari basic**

**Container sanitari premium**

**Accesso disabili**

**Prodotti aggiuntivi**

**Prodotti speciali**

**Serbatoi di scarico**

**Transenne di sicurezza e recinzioni**

# TOI® WATER

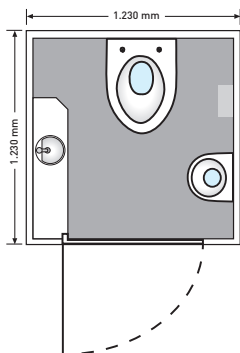

## Dati tecnici:

Dimensioni: 1,23 x 1,23 x 2,30m  
Peso: 123 kg  
Serbatoio di scarico: 250 l con doppia ventilazione integrata

## Dotazione:

WC  
Orinatoio  
Lavandino con riserva d'acqua da 60 litri  
Dispenser per rotoli di carta igienica  
Dispenser per sapone  
Rivestimento pavimento antiscivolo  
Contrassegno Donne/Uomini  
Chivistello interno con serratura esterna

# TOI® PLUS WASH

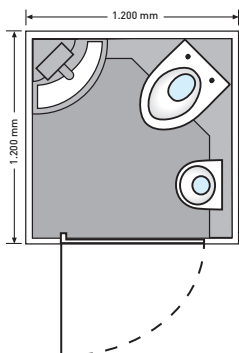

## Dati tecnici:

Dimensioni: 1,20 x 1,20 x 2,34m  
Peso: 120,5 kg  
Serbatoio di scarico: 225 l con doppia ventilazione integrata

## Dotazione:

WC  
Orinatoio  
Lavandino con riserva d'acqua da 35 litri  
Pompa attivabile con piede  
Grande dispenser per rotoli di carta igienica  
Dispenser per sapone  
Rivestimento pavimento antiscivolo  
Contrassegno Donne/Uomini  
Serratura integrata  
Indicazione «Occupato»

# TOI® WATER UP

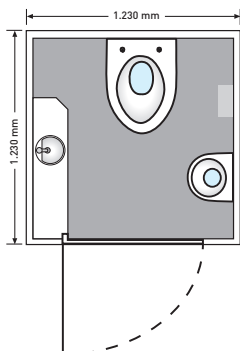

## Dati tecnici:

Dimensioni: 1,23 x 1,23 x 2,32m  
Peso: 124 kg  
Serbatoio di scarico: 250 l con doppia ventilazione integrata

## Dotazione:

WC  
Orinatoio  
Lavandino con riserva d'acqua da 60 litri  
Pompa attivabile con piede  
Dispenser per sapone  
Grande dispenser per rotoli di carta igienica  
Luce LED, a energia solare  
Ventilazione del serbatoio tramite ventilatore  
Contrassegno Donne/Uomini  
Indicazione «Occupato»

# TOI® HYGIENE+

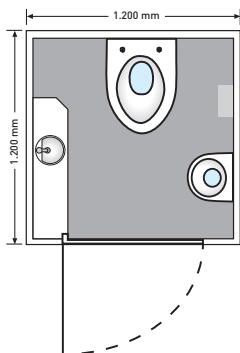

**99,9%**  
riduzione dei germi

## Dati tecnici:

Dimensioni: 1,20 x 1,20 x 2,32m  
Peso: 123 kg  
Serbatoio di scarico: 250 l con doppia ventilazione integrata

## Dotazione:

WC  
Orinatoio  
Lavandino con riserva d'acqua da 60 litri  
Robusta pompa a pedale  
Grande dispenser per rotoli di carta igienica  
Dispenser per sapone  
Rivestimento pavimento antiscivolo  
Serratura integrata  
Contrassegno Donne/Uomini  
Indicazione «Occupato»

# TOI® FRESH

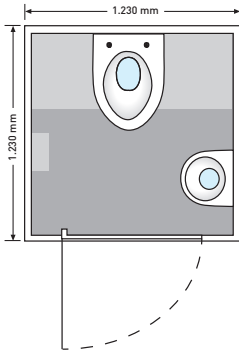

## Dati tecnici:

Dimensioni: 1,23 x 1,23 x 2,30m  
Peso: 82 kg  
Serbatoio di scarico: 250 l con doppia ventilazione integrata

## Dotazione:

WC  
Orinatoio  
Dispenser per rotoli di carta igienica  
Dispenser per la disinfezione delle mani  
Rivestimento pavimento antiscivolo  
Contrassegno Donne/Uomini  
Chivistello interno con serratura esterna



# TOI® PLUS

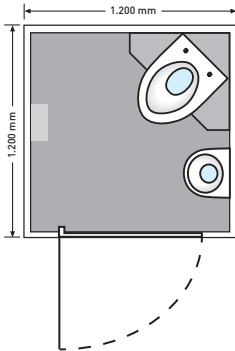

## Dati tecnici:

Dimensioni: 1,20 x 1,20 x 2,34m  
Peso: 108 kg  
Serbatoio di scarico: 225 l con doppia ventilazione integrata

## Dotazione:

WC  
Orinatoio  
Dispenser per rotoli di carta igienica  
Dispenser per la disinfezione delle mani  
Rivestimento pavimento antiscivolo  
Contrassegno Donne/Uomini  
Chiavistello interno con serratura esterna  
Contrassegno Donne/Uomini  
Serratura integrata  
Indicazione «Occupato»

# TOI® MINI BAGNO MOBILE

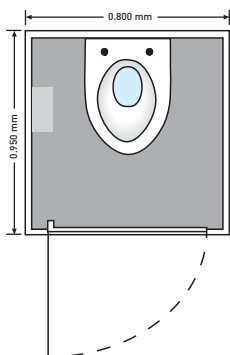

## Dati tecnici:

Dimensioni: 0,95 x 0,80 x 1,90m

Peso: 55 kg

Serbatoio: 100 litri

## Dotazione:

Chiusura ermetica del serbatoio

Dispenser per la disinfezione delle mani

Dispenser per rotoli di carta igienica

Ruote per facilitare il trasporto

Rivestimento pavimento antiscivolo

# TOI® CABINA MULTI-ORINATOIO

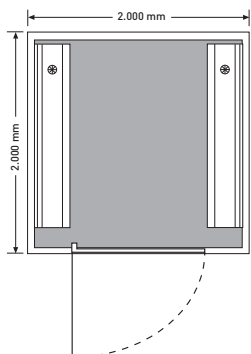

## Dati tecnici:

Dimensioni: 2,00 x 2,00 x 2,25m  
Peso: 200 kg  
Serbatoio di scarico: 2 x 250 litri

## Dotazione:

2 Orinatoi a canale  
Dispenser per la disinfezione delle mani  
Rivestimento pavimento antiscivolo

# TOI® SERBATOIO DA APPARTAMENTO

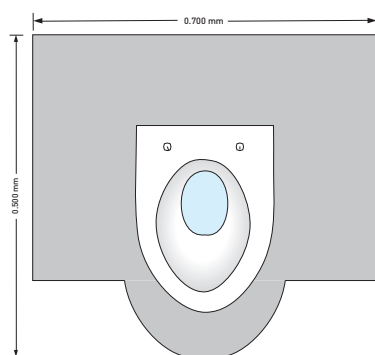

## Dati tecnici:

Dimensioni: 0,50 x 0,50 x 0,70 m

Peso: 11 kg

Serbatoio di scarico: 150 litri

## Dotazione:

WC

Maniglie per facilitare il trasporto

Chiusura antiodore

# TOI® ORINATOIO

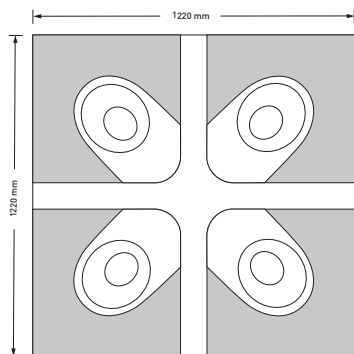
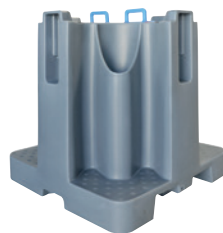

## Dati tecnici:

Dimensioni: 1,22 x 1,22 x 2,14m  
Peso: 60 kg  
Serbatoio di scarico: 560 litri  
Raccordi: 2 x 1" Camlock

## Dotazione:

4 orinatoi  
Pareti divisorie  
Impilabile  
Rivestimento pavimento antiscivolo



# TOI® MINI ORINATOIO

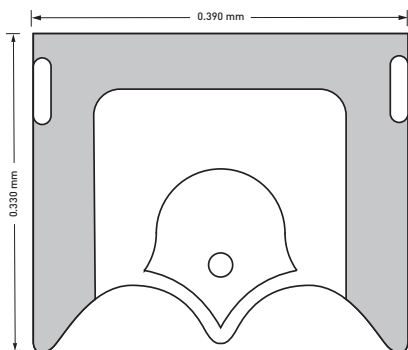

## Dati tecnici:

Dimensioni: 0,39 x 0,33 x 1,18m  
Peso: 11 kg  
Serbatoio di scarico: 40 litri

## Dotazione:

Orinatoio  
Maniglie per facilitare il trasporto  
Ruote per facilitare il trasporto

# TOI® TRAILER WC ECO T

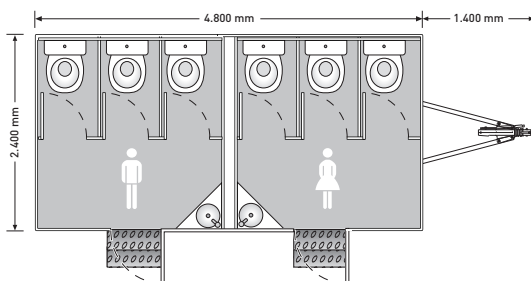

## Dati tecnici:

Dimensioni:	4,80 x 2,40 x 3,10m
Lunghezza timone:	1,40m
Peso:	1'500 kg
Allacciamento acqua:	3/4" GEKA
Allacciamento scarico:	Tube HT NW 110
Allacciamento elettrico:	230 V/16 A - luce
Consumo di elettricità:	5 kW - luce
Allacciamento elettrico:	400 V/16 A - luce/boiler/ riscaldamento
Consumo di elettricità:	7 kW - luce/boiler/ riscaldamento
Boiler:	10 litri

## Dotazione:

Donne:	3 WC, 1 lavandino
Uomini:	3 WC, 1 lavandino
Specchio	
Dispenser per sapone	
Riscaldamento	
Salviette di carta	
Gancio attaccapanni	

# TOI® TRAILER WC ECO PLUS

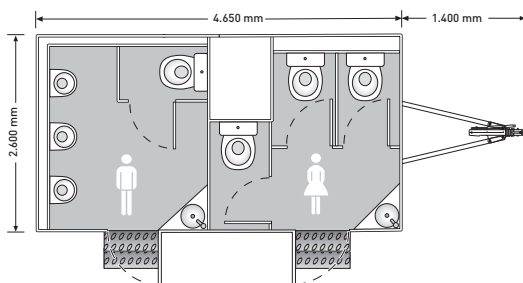

## Dati tecnici:

Dimensioni:	4,65 x 2,60 x 3,10m
Lunghezza timone:	1,40m
Peso:	1'500 kg
Allacciamento acqua:	3/4" GEKA
Allacciamento scarico:	Tubo HT NW 110
Allacciamento elettrico:	230 V/16 A - luce
Consumo di elettricità:	5 kW - luce
Allacciamento elettrico:	400 V/16 A - luce/boiler/ riscaldamento
Consumo di elettricità:	7 kW - luce/boiler/ riscaldamento
Boiler:	10 litri

## Dotazione:

Donne:	3 WC, 1 lavandino
Uomini:	1 WC, 3 orinatoi, 1 lavandino
Specchio	
Dispenser per sapone	
Riscaldamento	
Salviette di carta	
Gancio attaccapanni	



# TOI® TRAILER WC VIP DUO

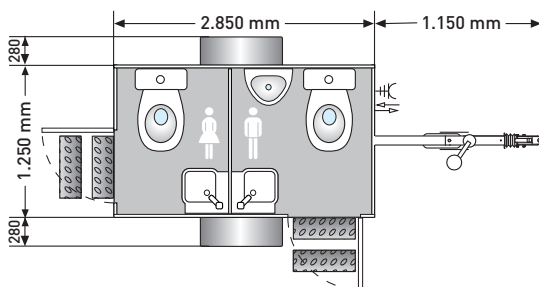

## Dati tecnici:

Dimensioni:	2,85 x 1,81 x 2,90m
Lunghezza timone:	1,15m
Peso:	580 kg
Allacciamento acqua:	3/4" GEKA
Allacciamento scarico:	Tubo HT NW 110
Allacciamento elettrico:	230 V/16 A - luce
Consumo di elettricità:	5 kW - luce
Allacciamento elettrico:	400 V/16 A - luce/boiler/ riscaldamento
Consumo di elettricità:	7 kW - luce/boiler/ riscaldamento
Boiler:	2 x 5 litri

## Dotazione:

Donne: 1 WC, 1 lavandino  
Uomini: 1 WC, 1 orinatoio, 1 lavandino  
Specchio  
Dispenser per sapone  
Riscaldamento  
Salviette di carta  
Gancio attaccapanni

# TOI® TRAILER WC VIP T

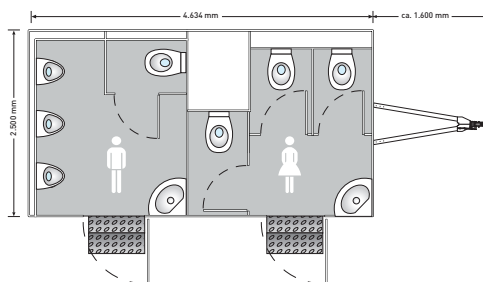

## Dati tecnici:

Dimensioni:	4.60 x 2.50 x 3.05m
Lunghezza timone:	1,57m (impennato lateralmente)
Peso:	1'800 kg
Allacciamento acqua:	3/4" GEKA
Allacciamento scarico:	Tubo HT NW 110
Allacciamento elettrico:	230 V/16 A - luce
Consumo di elettricità:	5 kW - luce 7 kW - luce/boiler/riscaldamento
Boiler:	10 litri

## Dotazione:

Donne:	3 WC, 1 lavandini
Uomini:	1 WC, 3 orinatoi, 1 lavandino
Specchio	
Dispenser per sapone	
Riscaldamento	
Salviette di carta	
Gancio attaccapanni	

# TOI® TRAILER WC VIP MAXI

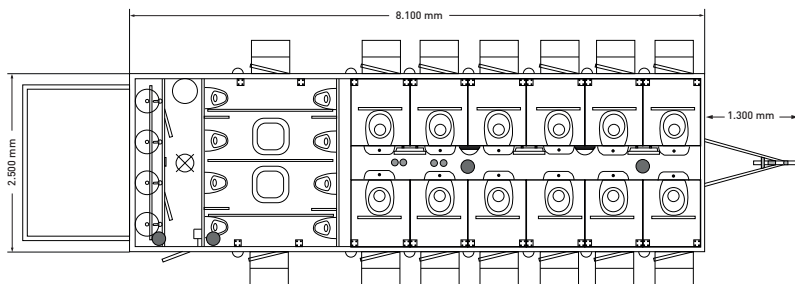

## Dati tecnici:

Dimensioni:	8,10 x 2,50 x 2,90m
Lunghezza timone:	1,30m
Peso:	3'500 kg
Allacciamento acqua:	3/4" GEKA
Allacciamento scarico:	Tubo HT NW 110
Allacciamento elettrico:	2 x 230 V/16 A
Consumo di elettricità:	6 kW - luce/boiler/ riscaldamento
Boiler:	30 litri

## Dotazione:

12 WC
8 orinatoi
4 lavandini
Specchio
Dispenser per sapone
Riscaldamento
Gancio attaccapanni

# TOI® TRAILER WC NOW AUTONOMO

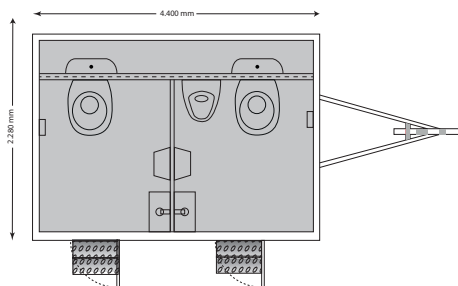
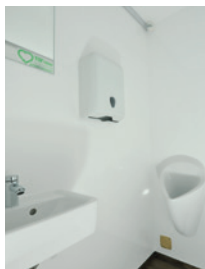

## Dati tecnici:

Dimensioni:	4,40 x 2,28 x 3,20m
Lunghezza timone:	1,60m
Peso:	1'100 kg
Serbatoio acqua pulita:	125 litri
Serbatoio acqua di scarico:	600 litri
Allacciamento elettrico:	230 V/16 A
Consumo di elettricità:	8 kW - luce/boiler/ riscaldamento
Boiler:	2 x 5 litri

## Dotazione:

Donne:	1 WC, 1 lavandino
Uomini:	1 WC, 1 orinatoio, 1 lavandino
Specchio	
Dispenser per sapone	
Riscaldamento	
Salviette di carta	
Gancio attaccapanni	
Serbatoio di acqua potabile integrata	
Serbatoio di acqua di scarico integrata	

# TOI® TRAILER WC VIP FUTURO

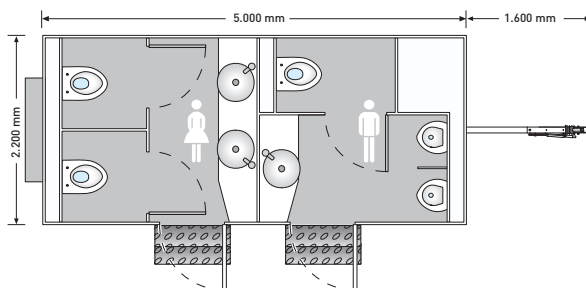

## Dati tecnici:

Dimensioni:	5,00 x 2,20 x 3,30m
Lunghezza timone:	1,60m (imperniato lateralmente)
Peso:	2'300 kg
Allacciamento acqua:	3/4" GEKA
Allacciamento scarico:	Tubo HT NW 110
Allacciamento elettrico:	230 V/16 A - luce
Allacciamento elettrico:	400 V/16 A - luce/boiler/ riscaldamento
Consumo di elettricità:	8 kW - luce/boiler/riscaldamento
Boiler:	5 litri

## Dotazione:

Donne:	2 WC, 2 lavandini
Uomini:	1 WC, 2 orinatoi, 1 lavandino
Specchio	
Dispenser per sapone	
Riscaldamento	
Salviette di carta	
Gancio attaccapanni	
Serbatoio di acqua potabile integrata	
Serbatoio di acqua di scarico integrata	

# TOI® TRAILER DOCCIA VIP

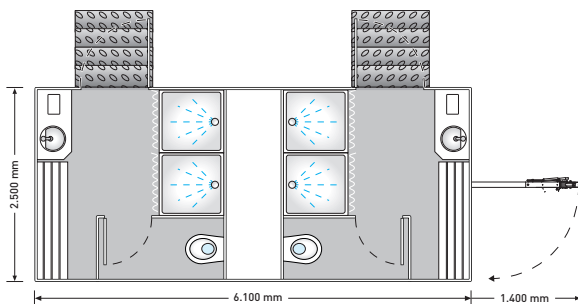

## Dati tecnici:

Dimensioni:	6,10 x 2,50 x 3,15m
Lunghezza timone:	1,40m (incernierata lateralmente)
Peso:	2'100 kg
Allacciamento acqua:	3/4" GEKA
Allacciamento scarico:	Tubo HT NW 110
Allacciamento elettrico:	400 V/16 A
Consumo di elettricit�:	16 kW - luce/boiler/ riscaldamento
Boiler:	2 x 80 litri

## Dotazione:

Donne:	1 WC, 2 docce, 1 lavandino
Uomini:	1 WC, 2 docce, 1 lavandino
Specchio	
Dispenser per sapone	
Riscaldamento	
Salviette di carta	
Guardaroba	

# TOI® MINI BAGNO MOBILE

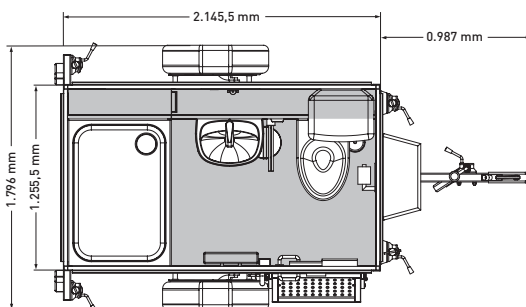

## Dati tecnici:

Dimensioni:	2,25 x 1,90 x 2,90m
Lunghezza timone:	1,12 m
Peso:	540 kg
Allacciamento acqua:	3/4" GEKA
Allacciamento scarico:	Tubo HT NW 110
Allacciamento elettrica:	400 V/32 A
Consumo di elettricità:	20 kW - luce/boiler/ riscaldamento
Trattamento acqua calda:	Scaldacqua istantaneo

## Dotazione:

1 WC
1 doccia
1 lavandino
Specchio
Dispenser per sapone
Riscaldamento
Porta asciugamani
Gancio attaccapanni

# TOI® BADMOBIL S

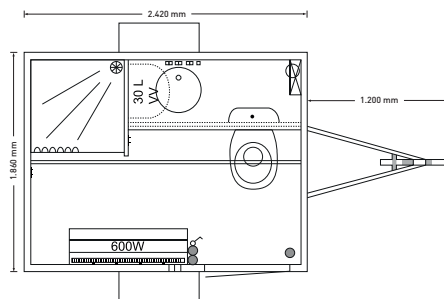

## Dati tecnici:

Dimensioni:	2,42 x 2,30 x 2,90m
Lunghezza timone:	1,20m
Peso:	750 kg
Allacciamento acqua:	3/4" GEKA
Allacciamento scarico:	1" Nito
Allacciamento elettrica:	400 V/16 A
Consumo di elettricità:	5 kW - luce/boiler/ riscaldamento
Boiler:	30 litri

## Dotazione:

1 WC
1 doccia
1 lavandino
Specchio
Dispenser per sapone
Riscaldamento
Salviette di carta
Gancio attaccapanni
Pompa acque di scarico integrata



# TOI® BADMOBIL M

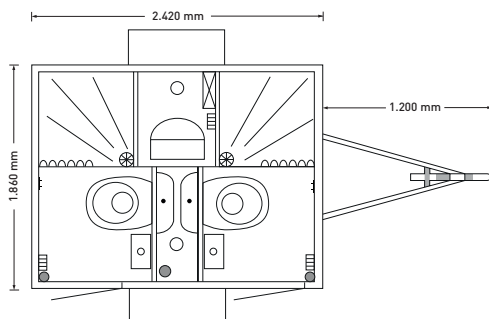

## Dati tecnici:

Dimensioni:	2,42 x 2,30 x 3,05m
Lunghezza timone:	1,20m
Peso:	1'000 kg
Allacciamento acqua:	3/4" GEKA
Allacciamento scarico:	1" Nito
Allacciamento elettrica:	400 V/16 A
Consumo di elettricità:	9 kW - luce/boiler/ riscaldamento
Boiler:	2 x 30 litri

## Dotazione:

2 WC
2 docce
2 lavandini
Specchio
Dispenser per sapone
Riscaldamento
Salviette di carta
Gancio attaccapanni
Pompa acque di scarico integrata

# TOI® BADMOBIL L

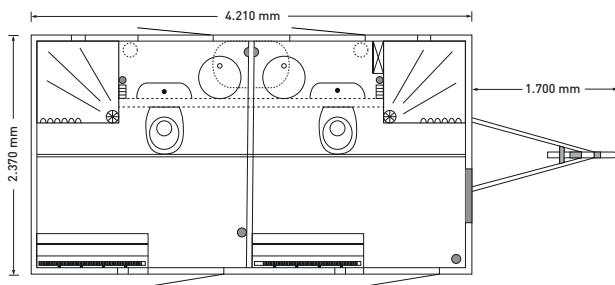

## Dati tecnici:

Dimensioni:	4,21 x 2,37 x 3,05m
Lunghezza timone:	1,70m
Peso:	1'300 kg
Allacciamento acqua:	3/4" GEKA
Allacciamento scarico:	1" Nito
Allacciamento elettrica:	400 V/16 A
Consumo di elettricità:	11 kW - luce/boiler/ riscaldamento
Boiler:	2 x 30 litri

## Dotazione:

2 WC
2 docce
2 lavandini
Specchio
Dispenser per sapone
Riscaldamento
Salviette di carta
Gancio attaccapani
Pompa acque di scarico integrata

# TOI<sup>®</sup> CONTAINER WC CUBUS D/H

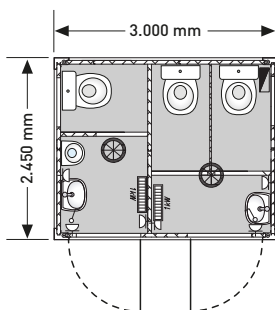

## Dati tecnici:

Dimensioni:	3,00 x 2,45 x 2,90m
Peso:	2'100 kg
Allacciamento acqua:	3/4" GEKA
Allacciamento scarico:	Tubo HT NW 110
Allacciamento elettrico:	400 V/32 A
Consumo di elettricità:	5 kW - luce
Consumo di elettricità:	9 kW - luce/boiler/ riscaldamento
Boiler:	2 x 5 litri

## Dotazione:

Donne:	2 WC, 1 lavandino
Uomini:	1 WC, 1 orinatoio, 1 lavandino
Specchio	
Dispenser per sapone	
Riscaldamento	
Salviette di carta	
Gancio attaccapanni	

**Le dotazioni possono variare, secondo l'anno di costruzione**

# TOI® CONTAINER WC CUBUS H

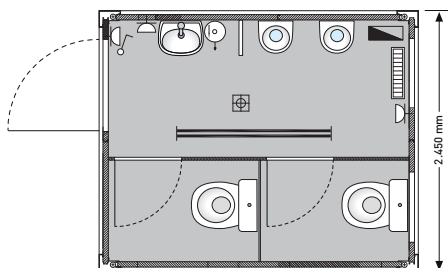

## Dati tecnici:

Dimensioni:	3,00 x 2,45 x 2,90m
Peso:	2'100 kg
Allacciamento acqua:	3/4" GEKA
Allacciamento scarico:	HT-Rohr NW 110
Allacciamento elettrica:	400 V/32 A
Consumo di elettricità:	3 kW - luce 5 kW - luce/boiler/riscaldamento
Boiler:	5 litri

## Dotazione:

2 WC
2 orinatoi
1 lavandino
Specchio
Dispenser per sapone
Riscaldamento
Salviette di carta
Gancio attaccapanni

**Le dotazioni possono variare, secondo l'anno di costruzione**

# TOI® CONTAINER WC CUBUS EDILIZIA

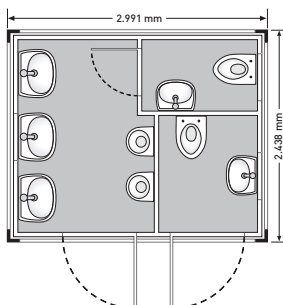

## Dati tecnici:

Dimensioni:	3,00 x 2,45 x 2,90m
Peso:	2'100 kg
Allacciamento acqua:	3/4" GEKA
Allacciamento scarico:	Tubo HT NW 110
Allacciamento elettrica:	400 V/32 A
Consumo di elettricità:	5 kW - luce 9 kW - luce/boiler/ riscaldamento
Boiler:	28 litri

## Dotazione:

Bagno uno:	1 WC, 2 orinatoi, 4 lavandini
Bagno due:	1 WC, 1 lavandino
Specchio	
Dispenser per sapone	
Riscaldamento	
Salviette di carta	
Gancio attaccapanni	

**Le dotazioni possono variare, secondo l'anno di costruzione**

# TOI® CONTAINER WC DOPPELSTAR

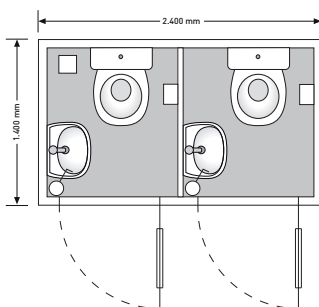

## Dati tecnici:

Dimensioni:	2,40 x 1,40 x 2,50m
Peso:	580 kg
Allacciamento acqua:	3/4" GEKA
Allacciamento scarico:	Tubo HT NW 110
Allacciamento elettrica:	400 V/32 A
Consumo di elettricità:	5 kW - luce 9 kW - luce/riscaldamento
Boiler:	2 x 5 litri

## Dotazione:

- 2 WC
- 2 lavandini
- Specchio
- Dispenser per sapone
- Riscaldamento
- Salviette di carta
- Gancio attaccapanni

**Le dotazioni possono variare, secondo l'anno di costruzione**

# TOI® CONTAINER WC BASIC LINE

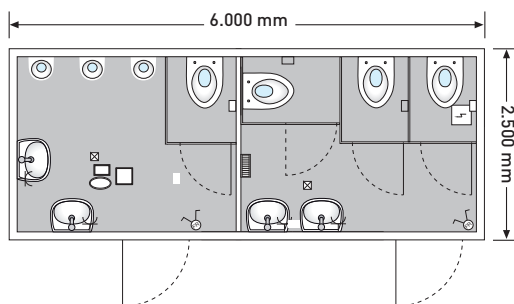

## Dati tecnici:

Dimensioni:	6,00 x 2,50 x 2,80m
Peso:	2'800 kg
Allacciamento acqua:	3/4" GEKA
Allacciamento scarico:	Tubo HT NW 110
Allacciamento elettrica:	400 V/32 A
Consumo di elettricità:	9 kW - luce 13 kW - luce/boiler/ riscaldamento
Boiler:	2 x 5 litri

## Dotazione:

Donne:	3 WC, 2 lavandini
Uomini:	1 WC, 3 orinatoi, 2 lavandini
Specchio	
Dispenser per sapone	
Riscaldamento	
Salviette di carta	
Gancio attaccapanni	

**Le dotazioni possono variare, secondo l'anno di costruzione**

# TOI® CONTAINER WC MAXI

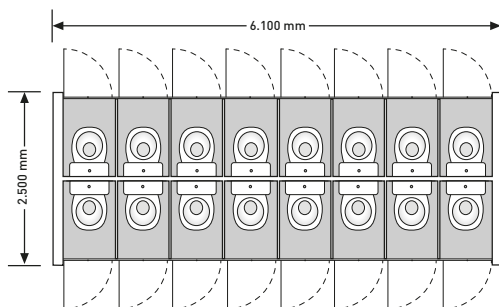

## Dati tecnici:

Dimensioni: 6,10 x 2,50 x 2,60m  
Peso: 2'600 kg  
Allacciamento acqua: 2 x 1" GEKA  
Allacciamento scarico: 2 x Tubo HT NW 110  
Allacciamento elettrica: 230 V/16 A  
Consumo di elettricità: 2 kW - luce  
Allacciamento elettrica: 400 V/32 A  
Consumo di elettricità: 4 kW - luce/riscaldamento

## Dotazione:

14 o 16 WC  
Lavandino maxi  
Porta rotoli per carta igienica  
Dispenser per sapone  
Riscaldamento  
Gancio attaccapanni

**Le dotazioni possono variare, secondo l'anno di costruzione**



# TOI® CONTAINER ORINATOIO MAXI

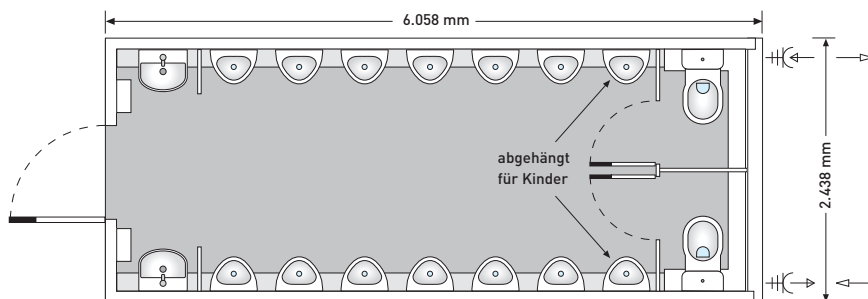

## Dati tecnici:

Dimensioni: 6,10 x 2,50 x 2,80m  
Peso: 3'000 kg  
Allacciamento acqua: 1" GEKA  
Allacciamento scarico: Tubo HT NW 110  
Allacciamento elettrica: 400 V/32 A  
Consumo di elettricità: 1 kW - luce/riscaldamento

## Dotazione:

14 orinatoi  
2 WC  
2 lavandini  
Specchio  
Dispenser per sapone  
Riscaldamento  
Salviette di carta

**Le dotazioni possono variare, secondo l'anno di costruzione**

# TOI® CONTAINER DOCCIA MAXI

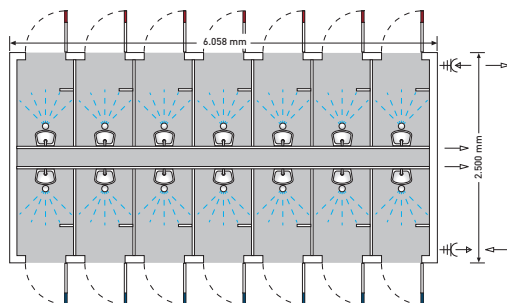

## Dati tecnici:

Dimensioni:	6,10 x 2,50 x 2,90m
Peso:	2'600 kg
Allacciamento acqua fredda:	1" GEKA
Allacciamento acqua calda:	1" GEKA
Allacciamento acqua circolazione:	3/4" GEKA
Allacciamento scarico:	Tubo HT NW 110
Allacciamento elettrico:	400 V/32 A
Consumo di elettricità:	1 kW - luce/riscaldamento
Trattamento acqua calda:	TOI® Hotmobil (esterno)

## Dotazione:

14 docce
14 lavandini
Specchio
Gancio attaccapanni
<b>Le dotazioni possono variare, secondo l'anno di costruzione</b>

# TOI® CONTAINER DOCCIA BASIC LINE

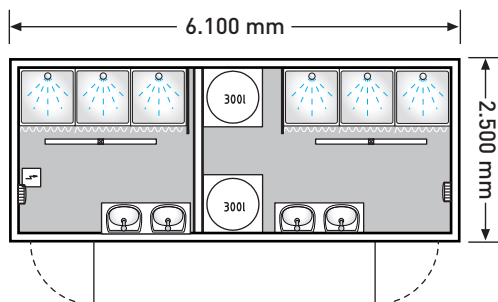

## Dati tecnici:

Dimensioni: 6,10 x 2,50 x 2,90m  
Peso: 4'500 kg  
Allacciamento acqua: 3/4" GEKA  
Allacciamento scarico: Tubo HT NW 110  
Allacciamento elettrica: 400 V/32 A  
Consumo di elettricità: 14 kW - luce/boiler  
18 kW - luce/boiler/  
riscaldamento  
Boiler: compreso

## Dotazione:

Donne: 3 docce, 2 lavandini  
Uomini: 3 docce, 2 lavandini  
Specchio  
Dispenser per sapone  
Riscaldamento  
Salviette di carta  
Gancio attaccapanni

**Le dotazioni possono variare, secondo l'anno di costruzione**

# TOI® CONTAINER CUBUS COMBI

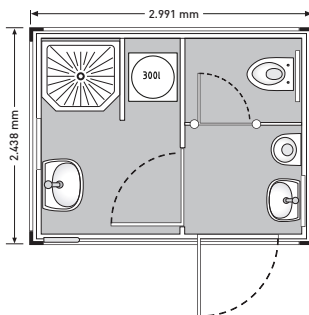

## Dati tecnici:

Dimensioni:	3,00 x 2,45 x 2,90m
Peso:	2'100 kg
Allacciamento acqua:	3/4" GEKA
Allacciamento scarico:	Tubo HT NW 110
Allacciamento elettrica:	400 V/32 A
Consumo di elettricità:	5 kW - luce 7 kW - luce/boiler/ riscaldamento
Boiler:	300 litri

## Dotazione:

1 WC
1 doccia
1 orinatoio
2 lavandini
Specchio
Dispenser per sapone
Riscaldamento
Salviette di carta
Gancio attaccapanni

**Le dotazioni possono variare, secondo l'anno di costruzione**

# TOI<sup>®</sup> CONTAINER COMBI 1.8

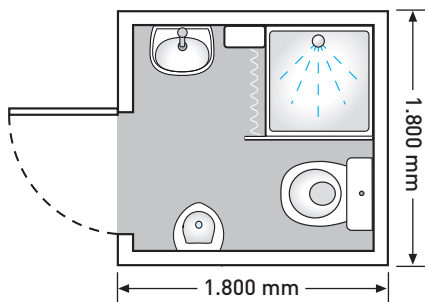
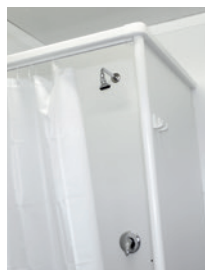

## Dati tecnici:

Dimensioni:	1,80 x 1,80 x 2,80m
Peso:	2'000 kg
Allacciamento acqua:	3/4" GEKA
Allacciamento scarico:	Tubo HT NW 110
Allacciamento elettrica:	400 V/32 A
Consumo di elettricità:	19 kW - luce/boiler 21 kW - luce/boiler/ riscaldamento
Trattamento acqua calda:	Scaldacqua istantaneo (elettrico)

## Dotazione:

1 WC
1 doccia
1 orinatoio
1 lavandino
Specchio
Dispenser per sapone
Riscaldamento
Salviette di carta
Gancio attaccapanni

**Le dotazioni possono variare, secondo l'anno di costruzione**

# TOI® CONTAINER WC PREMIUM LINE D/U

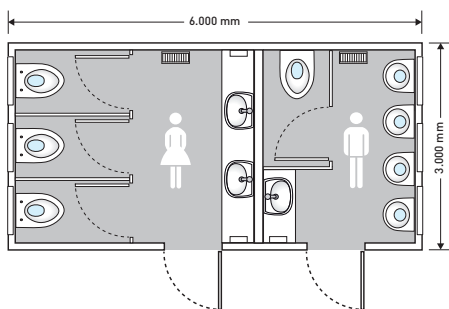

## Dati tecnici:

Dimensioni:	6,00 x 3,00 x 2,90m
Peso:	4'800 kg
Allacciamento acqua:	3/4" GEKA
Allacciamento scarico:	Tubo HT NW 110
Allacciamento elettrica:	400 V/32 A
Consumo di elettricità:	5 kW - luce 9 kW - luce/boiler/riscaldamento
Boiler:	3 x 5 litri

## Dotazione:

Donne:	3 WC, 2 lavandini
Uomini:	1 WC, 4 orinatoi, 1 lavandino
Specchio	
Dispenser per sapone	
Riscaldamento	
Salviette di carta	
Gancio attaccappanni	

**Le dotazioni possono variare, secondo l'anno di costruzione**

# TOI® CONTAINER WC PREMIUM LINE H

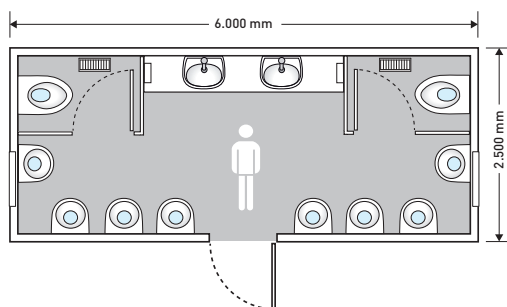

## Dati tecnici:

Dimensioni:	6,00 x 2,50 x 2,90m
Peso:	4'500 kg
Allacciamento acqua:	3/4" GEKA
Allacciamento scarico:	Tubo HT NW 110
Allacciamento elettrica:	400 V/32 A
Consumo di elettricità:	5 kW - luce 9 kW - luce/boiler/riscaldamento
Boiler:	2 x 5 litri

## Dotazione:

- 2 WC
- 8 orinatoi
- 2 lavandini
- Specchio
- Dispenser per sapone
- Riscaldamento
- Salviette di carta
- Gancio attaccapanni

**Le dotazioni possono variare, secondo l'anno di costruzione**

# TOI® CONTAINER WC PREMIUM LINE D

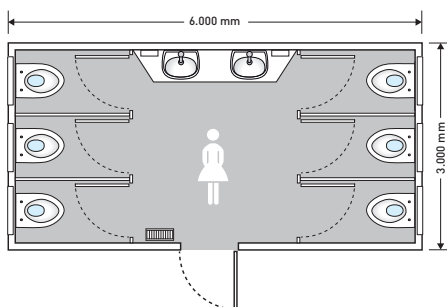

## Dati tecnici:

Dimensioni:	6,00 x 3,00 x 2,90m
Peso:	4'800 kg
Allacciamento acqua:	3/4" GEKA
Allacciamento scarico:	Tubo HT NW 110
Allacciamento elettrica:	400 V/32 A
Consumo di elettricità:	5 kW - luce 7 kW - luce/boiler/riscaldamento
Boiler:	2 x 5 litri

## Dotazione:

- 6 WC
- 2 lavandini
- Specchio
- Dispenser per sapone
- Riscaldamento
- Salviette di carta
- Gancio attaccapanni

**Le dotazioni possono variare, secondo l'anno di costruzione**



# TOI<sup>®</sup> DELUXE / BLACK (WC)

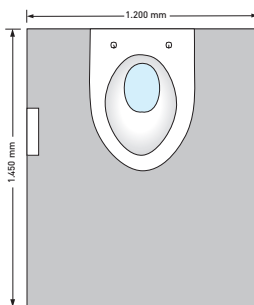

## Dati tecnici:

Dimensioni: 1,20 x 1,45 x 2,33m  
Peso: 380 kg  
Allacciamento acqua: 1/2" GEKA  
Allacciamento scarico: Tubo HT NW 110  
Allacciamento elettrica: 230 V/16 A  
Consumo di elettricità: 3 kW - luce/WC

## Dotazione:

WC  
Distributori di carta igienica  
Spazzola WC  
Gancio attaccapanni  
Pattumiera  
Illuminazione alogena

# TOI<sup>®</sup> DELUXE / BLACK (ORINATOIO)

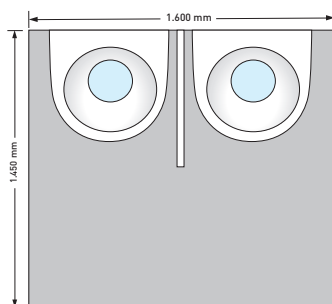

## Dati tecnici:

Dimensioni: 1,60 x 1,45 x 2,33m  
Peso: 580 kg  
Allacciamento acqua: 1/2" GEKA  
Allacciamento scarico: Tubo HT NW 110  
Allacciamento elettrico: 230 V/16 A  
Consumo di elettricità: 0,1 kW - luce  
Consumo di elettricità: 0,2 kW - luce/orinatoio

## Dotazione:

2 orinatoio  
Illuminazione alogena

# TOI<sup>®</sup> DELUXE / BLACK (LAVABO)

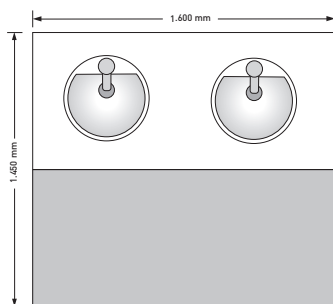

## Dati tecnici:

Dimensioni: 1,60 x 1,45 x 2,33m  
Peso: 680 kg  
Allacciamento acqua: 1/2" GEKA  
Allacciamento scarico: Tubo HT NW 110  
Allacciamento elettrico: 230 V/16 A  
Consumo di elettricità: 0,1 kW - luce  
Consumo di elettricità: 3 kW - luce/boiler

## Dotazione:

2 lavandini  
Illuminazione alogena  
Specchio  
Dispenser per sapone  
Salviette di carta  
Pattumiera

# TOI® TRAILER WC VIP CEREBRAL

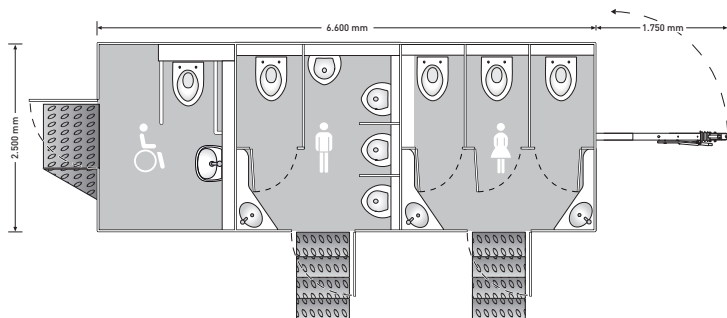

## Dati tecnici:

Dimensioni:	6,60 x 2,50 x 3,15m
Lunghezza timone:	1,75 m (ripiegabile lateralmente)
Peso:	3'490 kg
Allacciamento acqua:	3/4" GEKA
Allacciamento scarico:	Tubo HT NW 110
Allacciamento elettrica:	400 V/32 A
Consumo di elettricità:	1 kW - luce
Consumo di elettricità:	13 kW - luce/boiler/ riscaldamento
Boiler:	3 x 5 litri

## Dotazione:

Donne:	3 WC, 2 lavandini
Uomini:	1 WC, 4 orinatoi, 1 lavandino
Handicap:	1 WC, 1 lavandino
	Specchio di grandi dimensioni
	Dispenser per sapone
	Riscaldamento
	Salviette di carta
	Gancio attaccapanni

# TOI® TRAILER DOCCIA VIP CEREBRAL

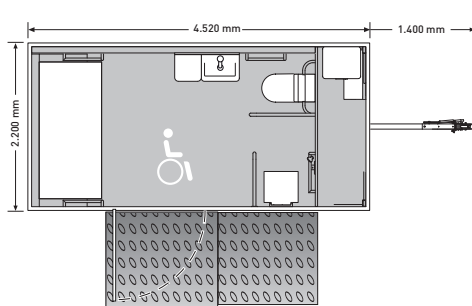

## Dati tecnici:

Dimensioni:	4,62 x 2,45 x 3,15m
Peso:	2'250 kg
Allacciamento acqua:	3/4" GEKA
Allacciamento scarico:	Tubo HT NW 110
Allacciamento elettrica:	400 V/16 A
Consumo di elettricità:	6 kW - luce/boiler/ riscaldamento
Boiler:	50 litri

## Dotazione:

1 WC
1 lavandino
1 doccia
1 panca
Specchio di grandi dimensioni
Dispenser per sapone
Riscaldamento
Salviette di carta
Gancio attaccapanni
Pompa acque di scarico integrata

# TOI<sup>®</sup> CAP CEREBRAL

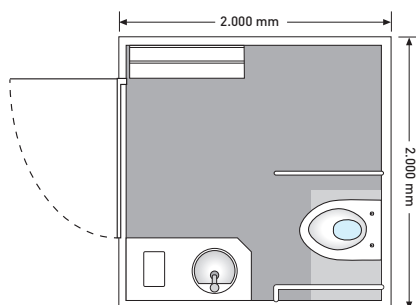

## Dati tecnici:

Dimensioni: 2,00 x 2,00 x 2,25m

Peso: 300 kg

Serbatoio: 150 litri

## Dotazione:

WC

Lavabo con serbatoio di acqua potabile

Dispenser per sapone

Salviette di carta

Rivestimento pavimento antiscivolo

Fasciatoio per i più piccoli

# TOI® CONTAINER WC CAP

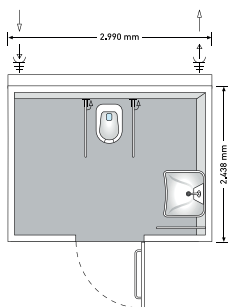

## Dati tecnici:

Dimensioni: 3,00 x 2,45 x 2,80m  
Peso: 2'400 kg  
Allacciamento acqua: 3/4" GEKA  
Allacciamento scarico: Tubo HT NW 110  
Allacciamento elettrica: 400 V/32 A  
Consumo di elettricità: 1 kW - luce  
3 kW - luce/riscaldamento

## Dotazione:

Toilette con maniglioni-corrimano  
Campanello di emergenza  
Lavandini  
Dispenser per sapone  
Riscaldamento  
Salviette di carta  
Gancio attaccapanni  
Fasciatoio per i più piccoli

# TOI® HOTMOBIL

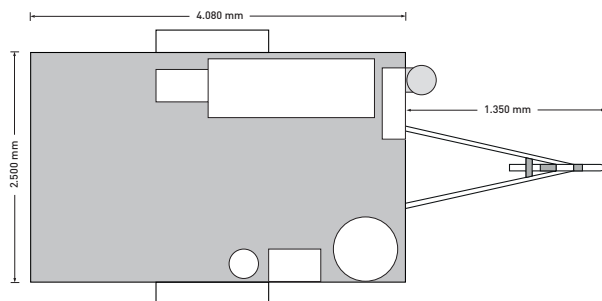

## Dati tecnici:

Dimensioni:	4,08 x 2,50 x 2,42m
Lunghezza timone:	1,35m
Peso a vuoto:	1'900 kg
Rendimento del calore:	270 kW
Quantità trasportata:	17 m <sup>3</sup> /h 8 m WS
Allacciamento elettrico:	230 V/16 A
Consumo di elettricità:	4 kW
Combustibile:	Olio da riscaldamento
Cisterna olio combustibile:	750 litri

## Dotazione:

Brucciatore
Vaso di espansione
Caldaia
Pompa
Controllo antigelo
Modulo acqua fresca
Tubo di scarico aria



# TOI® POMPA ACQUE DI SCARICO

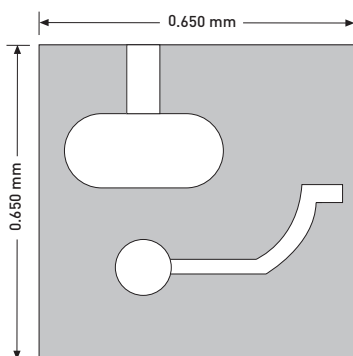

## Dati tecnici:

Dimensioni:	0,65 x 0,65 x 0,80m
Peso:	30 kg
Ingresso:	Tubo HT NW 110
Uscita:	Camlock
Allacciamento elettrico:	400 V/16 A
Consumo di elettricità:	2,6 kW
Capacità di pompaggio:	12 m3 / hr

## Dotazione:

Tritratore integrato  
Sistema di controllo di sicurezza

# TOI® POMPA DA CUCINA



## Dati tecnici:

Dimensioni:	0,40 x 0,28 x 0,30m
Peso:	10 kg
Ingresso:	Sifone Ø 40mm
Uscita:	Camlock
Allacciamento elettrico:	230 V/16 A
Consumo di elettricità:	0,2 kW
Capacità di pompaggio:	3.5m <sup>3</sup> / hr

## Dotazione:

Sistema di taglio integrato  
Controllo intuitivo  
Alto flusso della pomp

# TOI® SCALE SPECIALI

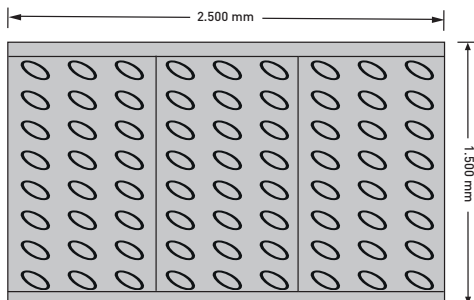

## Dati tecnici:

Dimensioni: 1,50 x 2,50 x 1,50m

Peso: 250 kg

## Dotazione:

Corrimano a destra e sinistra

Tre scalini

Rivestimento antiscivolo sul pavimento

Robusta costruzione in acciaio

Solo in connessione con TOI® Serbatoi di scarico - 10m<sup>3</sup>

# TOI® LAVAMANI MAXI

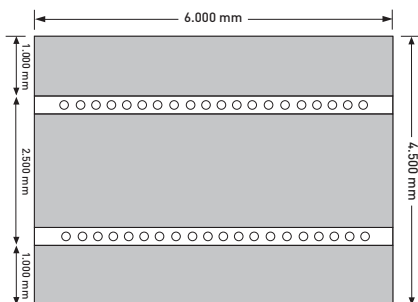

## Dati tecnici:

Lunghezza x Larghezza aperto: 6,00 x 4,50m

Lunghezza x Larghezza chiuso: 6,00 x 2,50m

Altezza: 1,33m

Peso: 1'260 kg

Allacciamento acqua: 3/4" GEKA

Allacciamento scarico: Tubo HT NW 110

## Dotazione:

2 lavandini maxi

40 rubinetti

2 tubi di scarico

4 ganci per gru integrati

4 pannelli laterali pieghevoli

Pavimento antiscivolo

# TOI® CARE HAND SANITIZER



## Dati tecnici:

Dimensioni: 0,50 x 0,50 x 1,23 m  
Peso: 12,5 kg (senza riempimento d'acqua o sabbia per appesantire)  
38 kg v (incl. serbatoio riempito da 10 litri e riempimento d'acqua per appesantire la parte  
Senza contatto: Senza alimentazione o batterie

## Dotazione:

1 Ugello a spruzzo  
1 Pompa a pedale  
Serbatoio di scambio da 10 litri con disinfettante per le mani  
4 piedini regolabili con 4x filettatura M8 (la filettatura M8 può essere utilizzata come optional per la protezione antifurto)  
Pittogrammi come istruzioni d'uso  
Informazioni dettagliate sugli ingredient

# TOI® LAVABO MULTIPLO

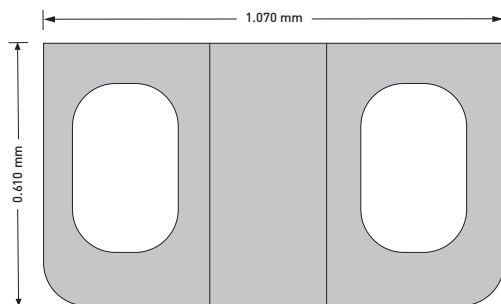

## Dati tecnici:

Dimensioni: 1,07 x 0,61 x 1,37m  
Peso: 55 kg  
Serbatoio d'acqua: 160 litri  
Serbatoio di scarico: 176 litri

## Dotazione:

2 lavandini  
2 pompe a pedale  
2 Dispenser per sapone  
Foro per l'ombrellone  
Senza cestino rifiuti, serviette per le mani e ombrellone

# TOI® PLUS FESTA MATRIMONIO

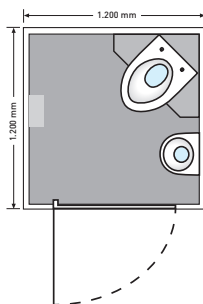

## Dati tecnici:

Dimensioni: 1,20 x 1,20 x 2,34m

Peso: 108 kg

Serbatoio: 225 litri con doppia ventilazione integrata

## Dotazione:

WC

Orinatoio

Dispenser per rotoli di carta igienica (chiuso)

Dispenser per la disinfezione delle mani

Rivestimento pavimento antiscivolo

Contrassegno Donne/Uomini

Chiavistello interno con serratura esterna

Indicazione «Occupato»

# TOI® PLUS FESTA COMPLEANNO

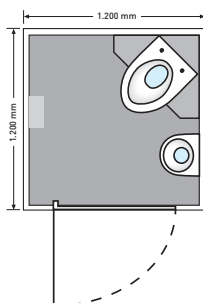

## Dati tecnici:

Dimensioni: 1,20 x 1,20 x 2,34m

Peso: 108 kg

Serbatoio: 225 litri con doppia ventilazione integrata

## Dotazione:

WC

Orinatoio

Grande dispenser per rotoli di carta igienica (chiuso)

Dispenser per la disinfezione delle mani

Rivestimento pavimento antiscivolo

Contrassegno Donne/Uomini

Chivistello interno con serratura esterna

Indicazione «Occupato»



# TOI® PLUS PARTY

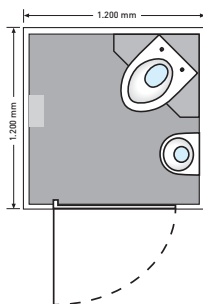
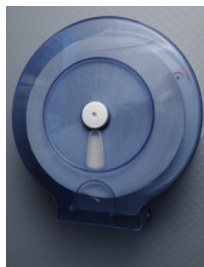

## Dati tecnici:

Dimensioni: 1,20 x 1,20 x 2,34m

Peso: 108 kg

Serbatoio: 225 litri con doppia ventilazione integrata

## Dotazione:

WC

Orinatoio

Grande dispenser per rotoli di carta igienica (chiuso)

Dispenser per la disinfezione delle mani

Rivestimento pavimento antiscivolo

Contrassegno Donne/Uomini

Chiavistello interno con serratura esterna

Indicazione «Occupato»

# TOI® TRAILER WC ECO ROBUSTAR

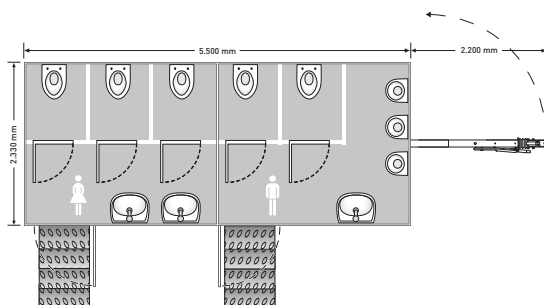

## Dati tecnici:

Dimensioni:	5,50 x 2,33 x 3,18m
Lunghezza timone:	2,20m
Peso:	2'700 kg
Allacciamento acqua:	3/4" GEKA
Allacciamento scarico:	Tubo HT NW 110
Allacciamento elettrico:	230 V/16 A - luce
Consumo di elettricità:	1 kW - luce
Allacciamento elettrico:	400 V/16 A - luce/riscaldamento
Consumo di elettricità:	2 kW - luce/riscaldamento

## Dotazione:

- Donne: 3 WC, 2 lavandini
- Uomini: 2 WC, 3 orinatoi, 1 lavandino
- Specchio di grandi dimensioni
- Dispenser per sapone
- Riscaldamento
- Salviette di carta
- Gancio attaccapanni

# TOI® SERBATOI DI SCARICO 1000 L

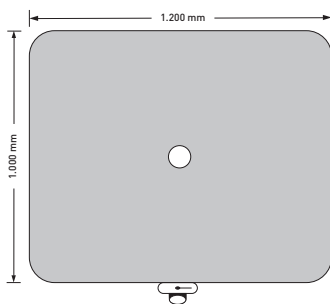

## Dati tecnici:

Dimensioni: 1,20 x 1,00 x 1,16m

Capacità: 1000 litri

Peso: 57 kg

## Caratteristiche:

Grande foro d'ingresso per il riempimento

Valvola di scarico

Punti di presa per muletto

# TOI® SERBATOI DI SCARICO 4000 L

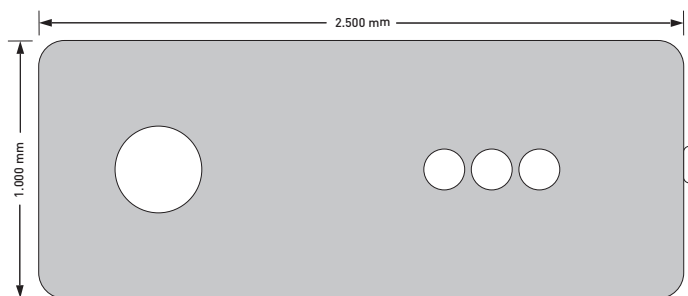

## Dati tecnici:

Dimensioni: 2,50 x 1,00 x 2,00m  
Capacità: 4000 litri  
Peso: 235 kg

## Caratteristiche:

Grande foro d'ingresso per il riempimento  
Valvola di scarico  
Punti di presa per muletto

# TOI® SERBATOI DI SCARICO - 10000 L

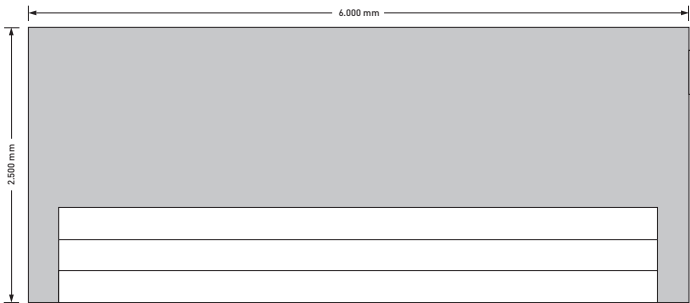

## Dati tecnici:

Dimensioni: 2,50/3,00 x 6,00 x 0,70m

Capacità: 10'000 - 12'000 litri

Peso: 1'500 - 1'700 kg

## Caratteristiche:

Foro d'ingresso e d'uscita

Punti di presa per muletto (interno 250 x 80 mm)

Indicatore del livello dell'acqua (tubo flessibile)

# TOI® TRANSENNE (MODELLO POLIZIA)

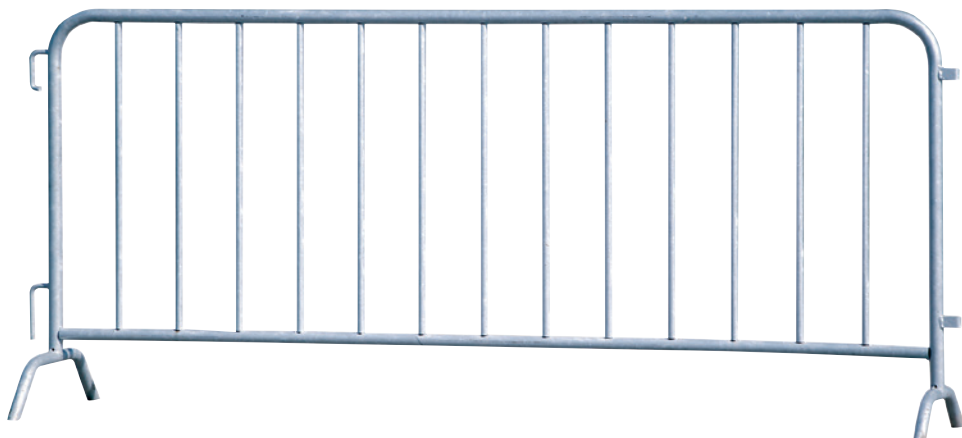

---

## Dati tecnici:

Dimensioni: 2,50 x 0,35 x 1,00m

Peso: 19 kg

---

## Caratteristiche:

In acciaio

Modulare (con ganci per l'unione)

Mobile, robusta

# TOI® RECINZIONI TEMPORANEE E MOBILI

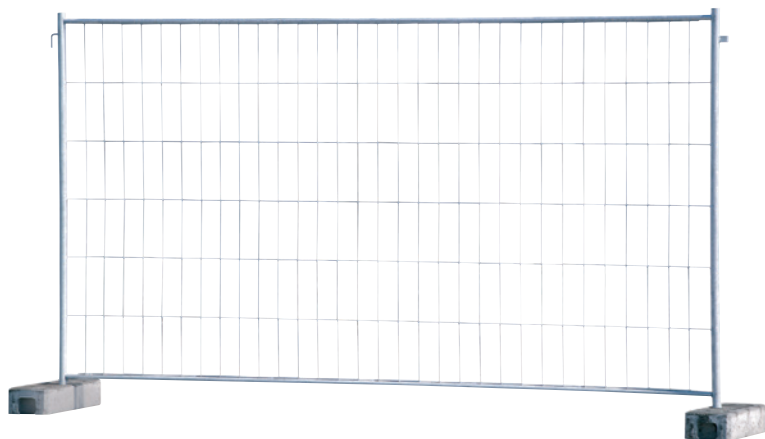

---

## Dati tecnici:

Recinzioni Dimensioni: 3,50 x 0,68 x 2,00m

Base Dimensioni: 0,68 x 0,25 x 0,14m

Recinzioni Peso: 16 kg

Base Peso: 26 kg

---

## Caratteristiche:

In acciaio

Modulare (con ganci e basamenti per l'unione)

Mobile, robusta

# EVENTI PRINCIPALI

Argovia Fäscht – Birrfeld  
Biathlon Arena – Lenzerheide  
Bike World Cup – Lenzerheide  
Breitling Event – Genève  
Carnevale Rabadan – Bellinzona Concour  
Hippique de la Dôle – Gingins Corn Rock  
Festival – Cornaux  
ESAF – Zug  
Fasnacht – Luzern  
Festival del film Locarno – Locarno



Granfondo SanGottardo – Airolo  
Greenfield – Interlaken  
Gurtenfestival – Gurten  
ICE Magic – Interlaken  
Jazztage – Lichtensteig  
JuBla- und Pfadilager – Schweizweit  
Konzerte – Schweizweit  
Lakesplash – Tann  
Longines CSI Ascona – Ascona  
Militär – Schweizweit  
Musikfest – Leukerbad



Omega Masters – Crans-Montana Open  
AIR – Frauenfeld  
Rägi rockt – Regensdorf  
Richemont Suisse SA – Villars-sur-Glâne  
Rock the Ring – Hinwil  
SBB – Schweizweit  
Seeüberquerung – Zürich  
SkiMarathon – Engadin  
SKI WM 2017 – St. Moritz



slowUp Ticino – Locarno-Bellinzona  
Snowpenair – Interlaken  
Snow Polo – St. Moritz  
SOLA Stafette – Zürich  
Stadtfest – Chur  
Swiss Alpine Marathon – Davos  
SwissCityMarathon – Luzern  
Swiss Labyrinth – Delémont  
Swiss Marathon light – Sarnen  
Tour de Ski – Val Mustair



Trucker Festival – Interlaken  
Vallemaggia Magic Blues – Avegno  
Verzasca Country Festival – Sonogno  
WEF – Davos  
Walliseller Lauf – Wallisellen  
Walking Day Ticino – Lugano  
White Turf – St. Moritz  
Zermatt Marathon – Zermatt





# NOSTRI PARTNER

## DÜRING

WIR ENTSORGEN. NATÜRLICH.



### Düring AG

Una solida azienda a conduzione familiare dal 1953. Soluzioni per lo smaltimento per aziende, privati, grandi eventi e feste. Ecologica, efficiente e performante.

Düring si impegna a riciclare i rifiuti, trasformandoli nuovamente in materie prime riutilizzabili. Il riciclo dei rifiuti è indispensabile in un paese povero di materie prime ma altamente innovativo. Düring è un'azienda a conduzione familiare leader nel settore ecologico nella Svizzera centrale. E si fa «protettrice» della natura, che va rispettata ogni giorno.

Insieme al nostro partner ci occupiamo dello smaltimento finale completo.



### eps Schweiz AG

Il nostro partner per i servizi infrastrutturali nel settore delle manifestazioni che si occupa di sistemi di tutela del suolo e di barriere e transenne. Proteggere il prato, rendere invisibili cavi e condutture di ogni genere, nascondere alla vista determinate zone e guidare il pubblico con transenne e barriere? Ci pensa il nostro partner con la sua infrastruttura professionale.



## BAUKADER.CH

### Baukader Schweiz

Quadri dell'edilizia Svizzera offre numerosi vantaggi tangibili che vanno ben oltre la formazione e condizioni di lavoro eque. Approfittatene! Grazie a questa collaborazione offriamo aiuto al personale in cantiere per tutto quello che riguarda i sistemi sanitari mobili. Favoriamo il costante scambio di conoscenze in tutta la Svizzera e siamo un partner leale e competente nel settore edile.



### Cerebral

La fondazione svizzera per i bambini con paralisi cerebrale aiuta oltre 8900 famiglie in tutta la Svizzera e i loro cari affetti da questa patologia. La nostra collaborazione si concentra sull'utilizzo delle migliori innovazioni per offrire sul mercato soluzioni sanitarie mobili senza barriere per i disabili. Il nostro obiettivo comune è di offrire proprio a queste persone un luogo che soddisfi i più elevati standard in termini di assenza di barriere, sicurezza e discrezione.

# IMPRESSIONI



# ECCO COME FUNZIONA...

## Cabine sanitarie:

La consegna avviene il più presto possibile dal lunedì al venerdì, dalle 6 alle 17 circa. In casi specifici, la consegna viene concordata con il cliente.

Per ogni ordine sono necessari: indirizzo esatto della consegna, un contatto con numero di cellulare, eventuali dettagli. Importante: il bagno deve essere raggiungibile dai nostri veicoli di servizio (massimo 5 metri), la posa avviene senza grù.

Il ritiro viene programmato sulla base della fine dei lavori. In caso di sospensione dei lavori (es. vacanze prolungate), la cabina sanitaria resta sul posto, ma non viene pulita e nemmeno fatturata.

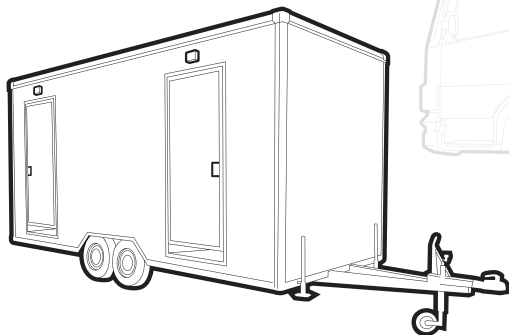
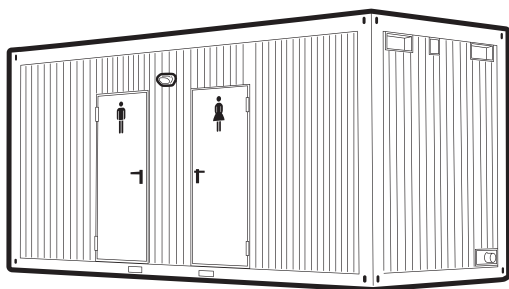

## I nostri rimorchi WC e container sanitari mobili

sono stati concepiti per qualsiasi manifestazione o cantiere.

L'installazione ideale è con un collegamento diretto alla linea fognaria, ma può essere eseguita anche in modo indipendente, con l'utilizzo di una pompa e una cisterna per le acque reflue. In ogni caso servono un allacciamento all'acqua potabile e un collegamento elettrico idoneo (questo varia a seconda del modello). Per la posa di rimorchi WC e container, servono strade d'accesso sufficientemente larghe, terreni solidi e piani. Solitamente è il cliente a occuparsi dei permessi e eventuali autorizzazioni, ma potete sempre chiedere il nostro aiuto.

La TOI TOI AG offre un servizio completo: trasporto (consegna e ritiro), installazione (montaggio e smontaggio), allacciamenti per acqua e scarichi (materiale compreso), fornitura e rifornimento del materiale di consumo, pulizie in base alle esigenze del cliente, pulizia finale. Inoltre, su richiesta per le manifestazioni, assistenza durante i giorni dell'evento.

# LE NOSTRI SEDI



## Amministrazione:

TOI TOI AG, Furtbachstrasse 14, 8107 Buchs

[www.toitoy.ch](http://www.toitoy.ch)  
[info@toitoy.ch](mailto:info@toitoy.ch)

**Tel. 0800 864 000**

(gratuito all'interno CH)

**Tel. +41 43 322 47 87**

(a pagamento dall'esterno CH)

## Sede Zurigo

Furtbachstrasse 14, 8107 Buchs (ZH)

## Sede Lucerna

Staldenhof 3b, 6014 Luzern (LU)

## Sede Basilea

Lehenmattstrasse 383, 4052 Basel (BS)

## Sede Grigioni

Polenlöserweg 10, 7204 Untervaz (GR)

## Sede Seeland

Bielstrasse 26, 2555 Brugg (BE)

## Sede Romandie

Chemin des Taborneires 8, 1350 Orbe

## Sede Zurigo nord

Buchenhagstrasse, 8156 Oberhasli (ZH)

## Sede Berna

Fahrhubelweg 4, 3123 Belp (BE)

## Sede Zugo

Gulmmatt, 6340 Baar (ZG)

## Sede Svizzera orientale

Herbergstrasse 27, 9524 Zuzwil (SG)

## Sede Svizzera centrale

Chlifeldweg 3, 6262 Langnau b. Reiden (LU)

## Sede March

Industriestrasse 17, 8864 Reichenburg (SZ)

## Sede Ticino

Via Sceresa 9, 6805 Mezzovico (TI)